

METALMASTER WT16-CSQ100



Clamping Square

140 x 90 x 105 x 50mm, 3 machined faces, 100mm high



METALMASTER Clamping Square WT16-CSQ100

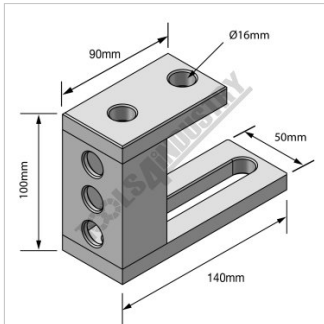

Dimensions



Clamping Square 100mm



Low View



100mm 200mm 300mm
Range Available

Description

These three-sided clamping squares feature machined square surfaces for a variety of clamping applications. Clamping squares can be used as part of your framework to support clamps & other fixtures at varying heights.

Stack clamping squares as needed to match the height of tall workpieces or add fixture components such as V-Blocks to hold your workpiece vertically or horizontally. The combination of holes and slots provide unlimited versatility in clamping, locating and positioning.

Features

- 12mm thick steel construction
- Includes 5 x Ø16mm hole & 1 x 105mm slot
- 3 machined faces

Specifications

ORDER CODE	W07846
MODEL	WT16-CSQ100
Type	Clamping Square
Suits Table Hole Diameter (Ø (mm))	Ø16mm
Size (mm)	140 x 90 x 100 x 50mm
Slot Length (mm)	~
Nett Weight (kg)	0.32