

SAFEWAY VQV-160V



Safeway Compact Power Machine Vice

160 x 300mm



SAFEWAY Safeway Compact Power Machine Vice VQV-160V

Description

Precision Power Machine Vice with modular jaws. Replaceable jaws allow for special purpose holding of components. The spindle allows for pre-setting of the clamping pressure

Features

- Power pre-set operation
- Maximum opening capacity yet compact in overall length
- Toleranced all over for use with other vices as matched pairs
- Rigid material- Ductile Iron FCD60 JIS. Equal to GGG60. 80,000 psi tensile strength.
- Flame hardened to HRC 45
- Chip cover to protect leadscrew
- Jaws hardened to HRC 52-55

Specifications

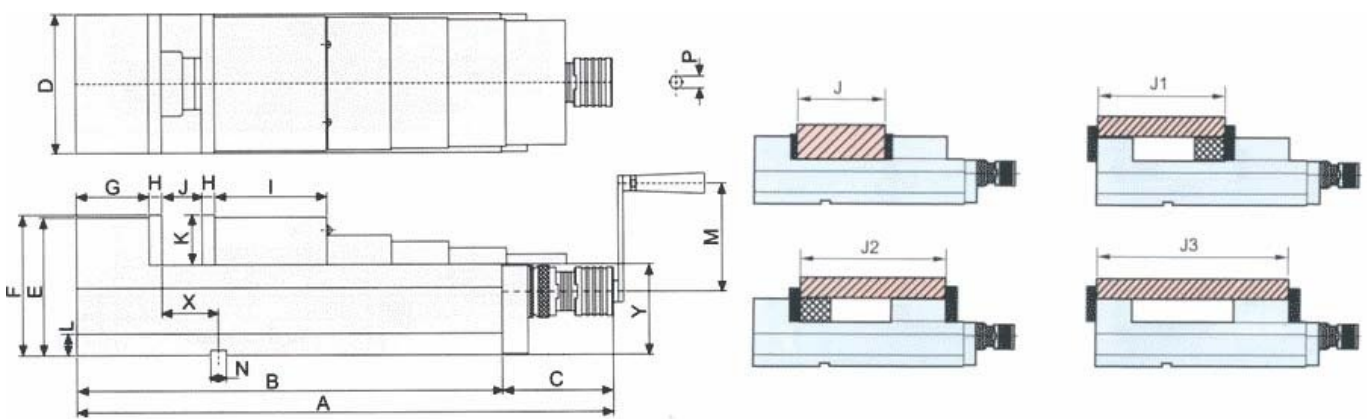

ORDER CODE	V357
MODEL	VQV-160V
Jaw Width (mm)	160
Pressure (kgf)	5292
A (mm)	581
B (mm)	475
C (mm)	106
D (mm)	161
E (mm)	152
F (mm)	160
G (mm)	86
I (mm)	86
J (mm)	0 - 300
K (mm)	55
M (mm)	125

SAFEWAY Safeway Compact Power Machine Vice VQV-160V

N (mm)	18
X (mm)	65
Y (mm)	105
Nett Weight (kg)	62