

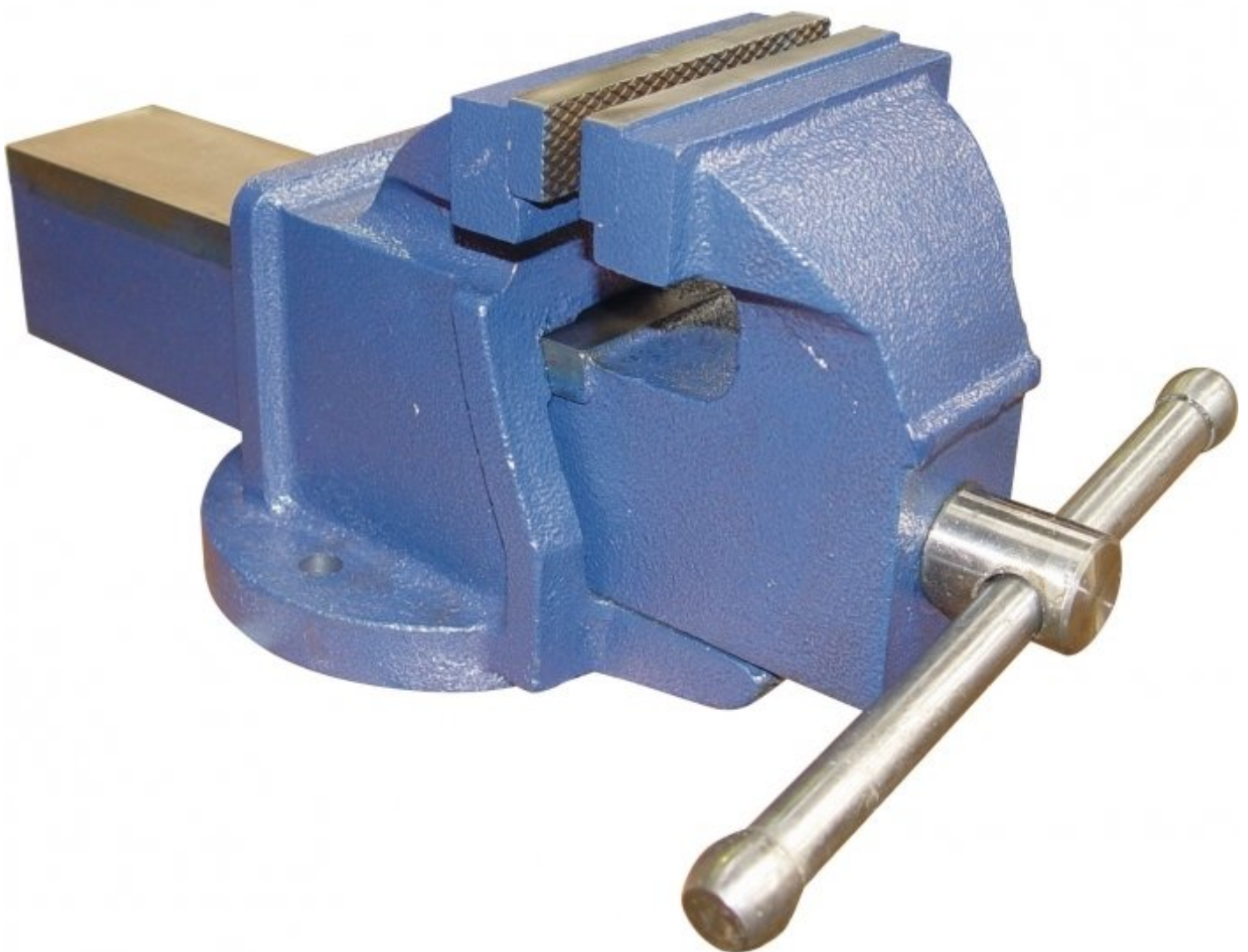

TOOLMASTER No. 5

127mm Cast Iron Bench Vice



TOOLMASTER 127mm Cast Iron Bench Vice No. 5

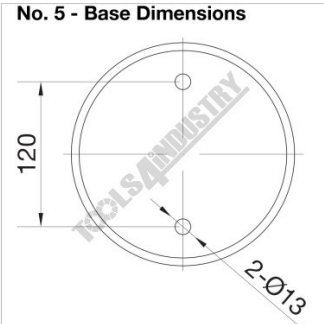

Base Dimensions

Description

Manufactured from nodular cast iron, and comes fitted with serrated jaws

Features

- Acme screw thread

Specifications

ORDER CODE	V089
Model	No. 5
Type	Bench
Jaw Width (mm)	127
Jaw Height	~
Jaw Opening (mm)	150
Overall Length (Closed Jaws) (mm)	410
Overall Width (mm)	160
Overall Height (mm)	170
Clamping Force (KN)	~
Nett Weight (kg)	17