

TOOLMASTER



BT40 x ER32-70 Collet Chuck

Ø2-Ø20mm Range



TOOLMASTER BT40 x ER32-70 Collet Chuck

Description

All BT collet chucks meet the specifications of machine tool builders (DIN 2080 taper Shank Grade AT-3 - 85% taper contact)

Features

- Precision ground
- Manufactured to MAS403BT40 standard
- M16 Pull Stud thread
- 70mm extension from the gauge line
- Locking spanner not included

Specifications

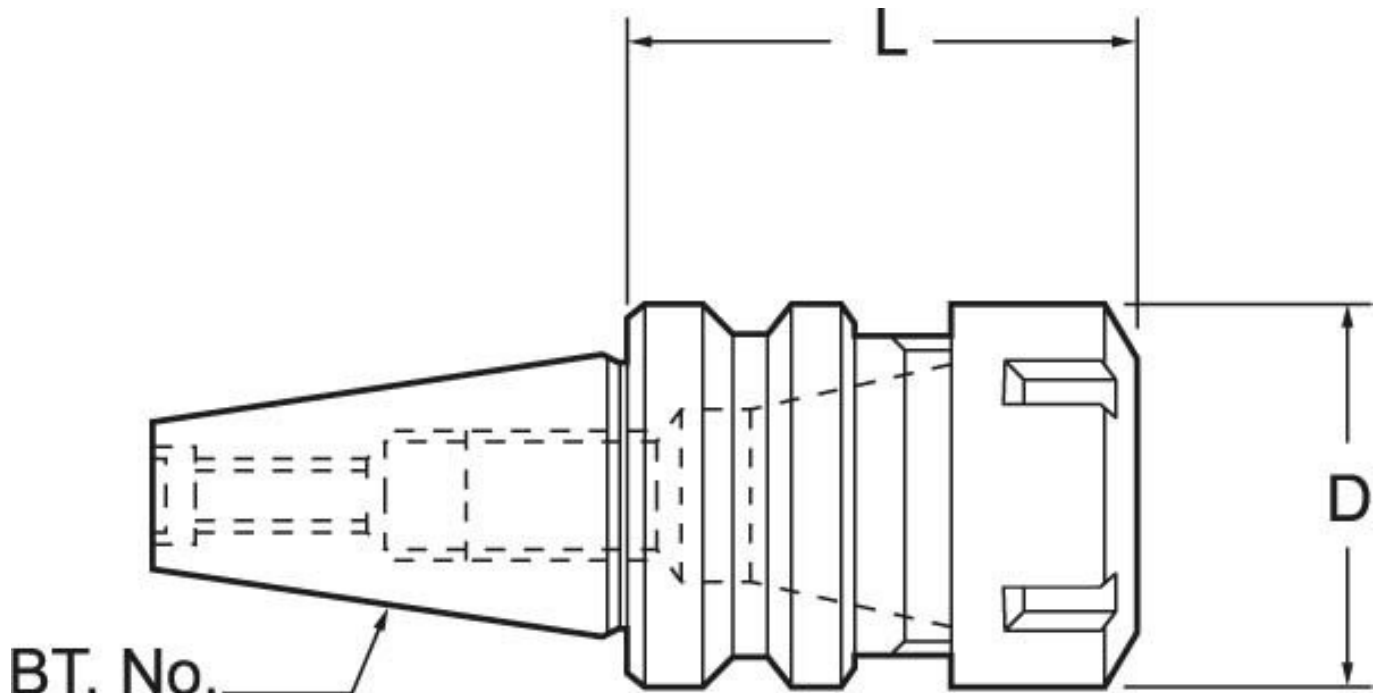

BT. No.	
ORDER CODE	T220
MODEL	BT40 x ER32-70
Speed Rating (rpm)	15,000
Taper (BT)	BT40
Capacity (mm)	2 - 20
L (mm)	70
D (mm)	50
Collet Type (ER)	ER32
Nett Weight (kg)	1.7