

VERTEX HV-10



Vertex Rotary Table

Ø254mm



VERTEX Vertex Rotary Table HV-10

Vertical View

Description

Manufactured in Taiwan

The Vertex Rotary Table has been designed to be used where a precision work positioning device is required. It allows the operator to mill or drill components at exact intervals around a fixed axis.

Additional indexing plates can be fitted to allow the Vertex Rotary Table to be used as a Dividing Head.

The Vertex Rotary Table can be used in both the horizontal or vertical plane.

Features

- The Vertex Rotary Table is manufactured from high-density Meehanite cast iron with ground surface areas on the table and body to ensure smooth rotation
- Critical wear parts are hand finished for ultra precision
- All tables are tested for accuracy using 'Heidenhain' electronic equipment to ensure continuing quality
- Worm is hardened and precision ground, with a ratio of 90:1
- Table is graduated to a full 360° so one turn of the handle moves the table 4°
- The collar on the handle is graduated with a vernier scale, readings down to 10 seconds are possible

Specifications

VERTEX Vertex Rotary Table HV-10

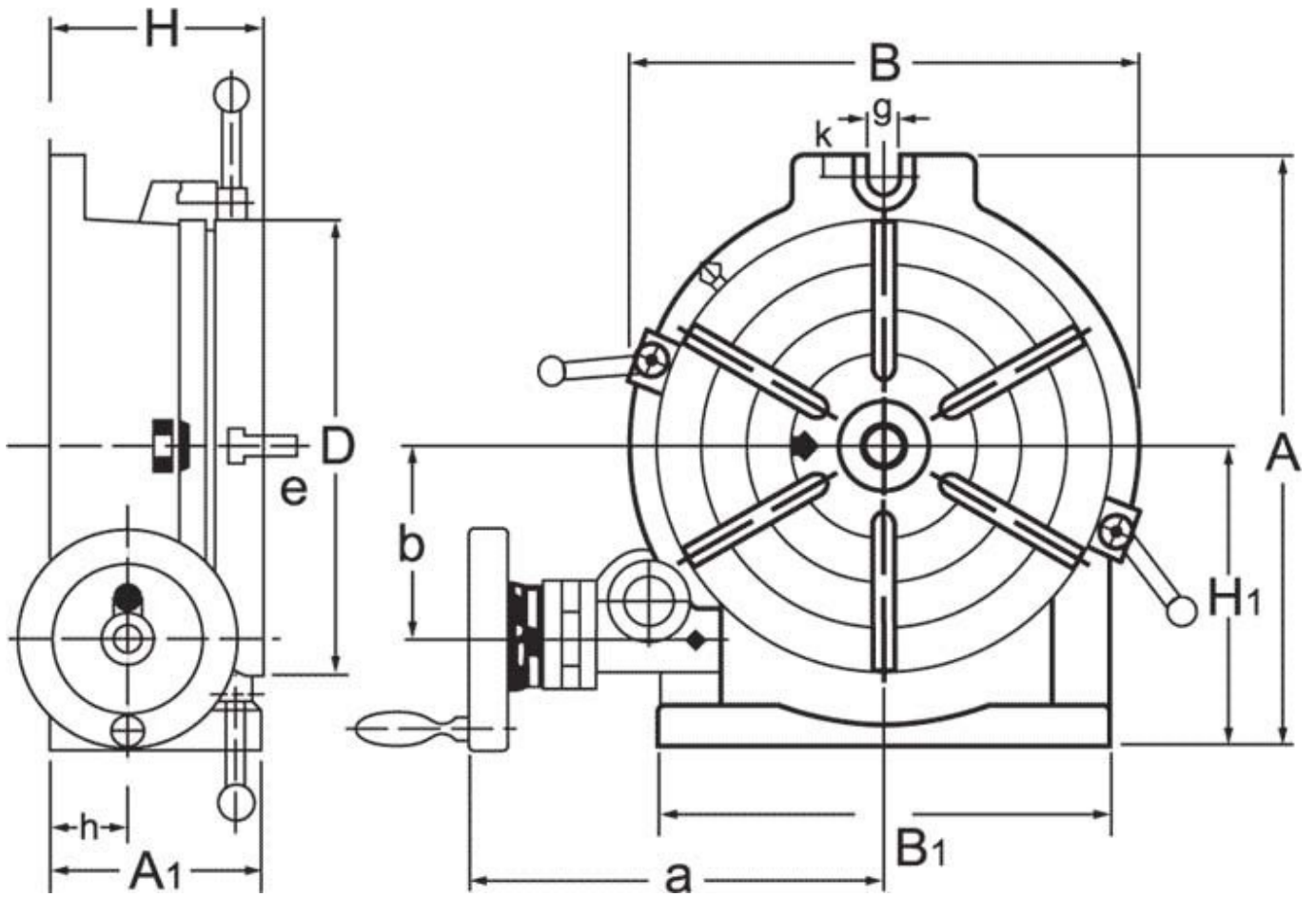

VERTEX Vertex Rotary Table HV-10

ORDER CODE

VERTEX Vertex Rotary Table HV-10

R010

MODEL	HV-10
Size (mm)	254
A1 (mm)	110
D (mm)	250
H (mm)	115
H1 (mm)	165
A (mm)	325
B (mm)	280
e (mm)	14
g (mm)	17
Number of T-Slots (No.)	6
T-Slot Size (mm)	14
Taper In Centre (MT)	3MT
Nett Weight (kg)	40