

MEASUMAX 45-5013

Micrometers - Jaw Type

50-75mm



Measumax



MEASUMAX Micrometers - Jaw Type 45-5013



Anvils

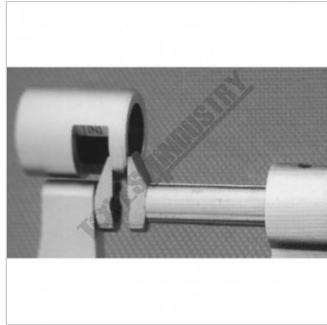

Shown Measuring

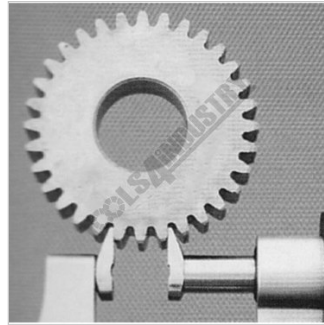

Shown Measuring

Description

The Measumax Jaw Type Micrometer is specially designed for measuring gear tooth dimensions and hard to reach recesses and grooves

Features

- Non Rotating spindle
- Ratchet thimble
- Painted frame
- Resolution 0.01 mm

Specifications

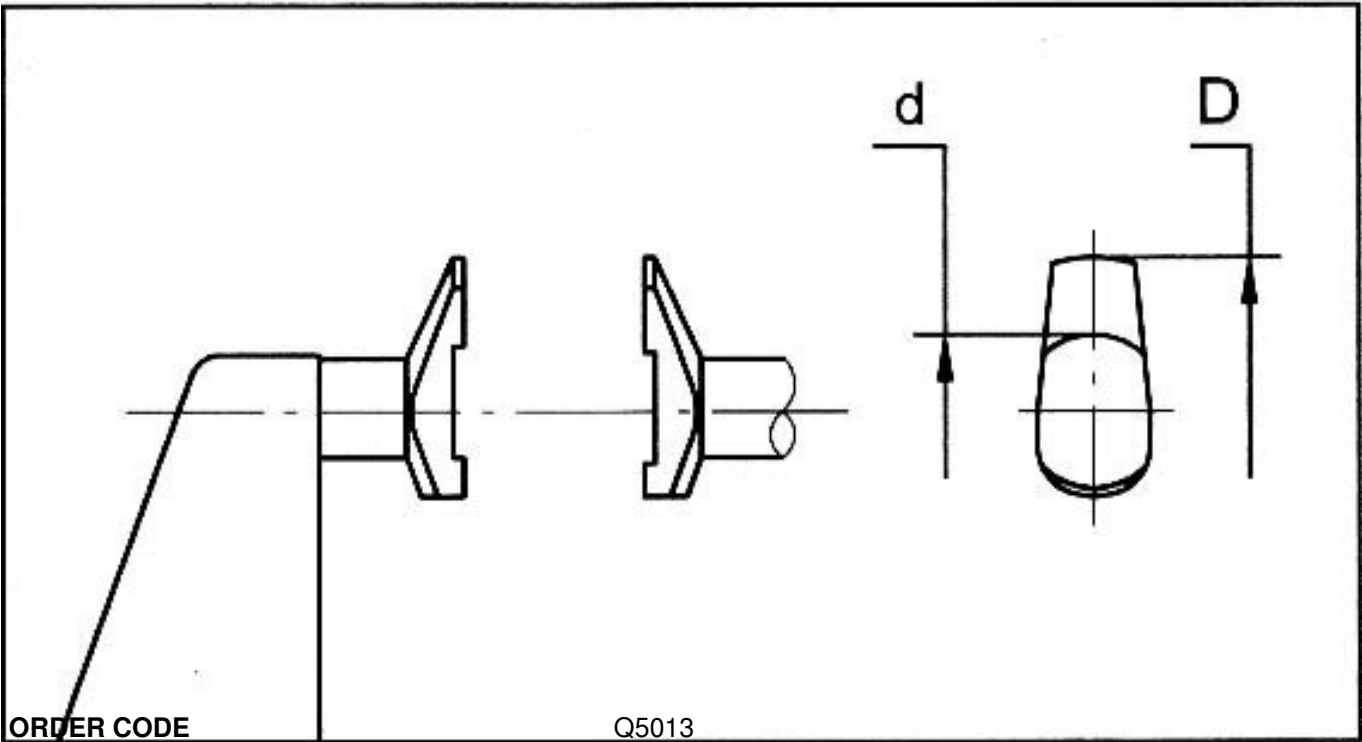

ORDER CODE	Q5013
Range (mm)	50 - 75
Accuracy (mm)	0.005
d (lowercase) (mm)	Ø8

MEASUMAX Micrometers - Jaw Type 45-5013

D (Radius) (mm)	10
------------------------	----
