

MEASUMAX 33-1996



MeasumaX

Vernier Calipers

2000mm/78"

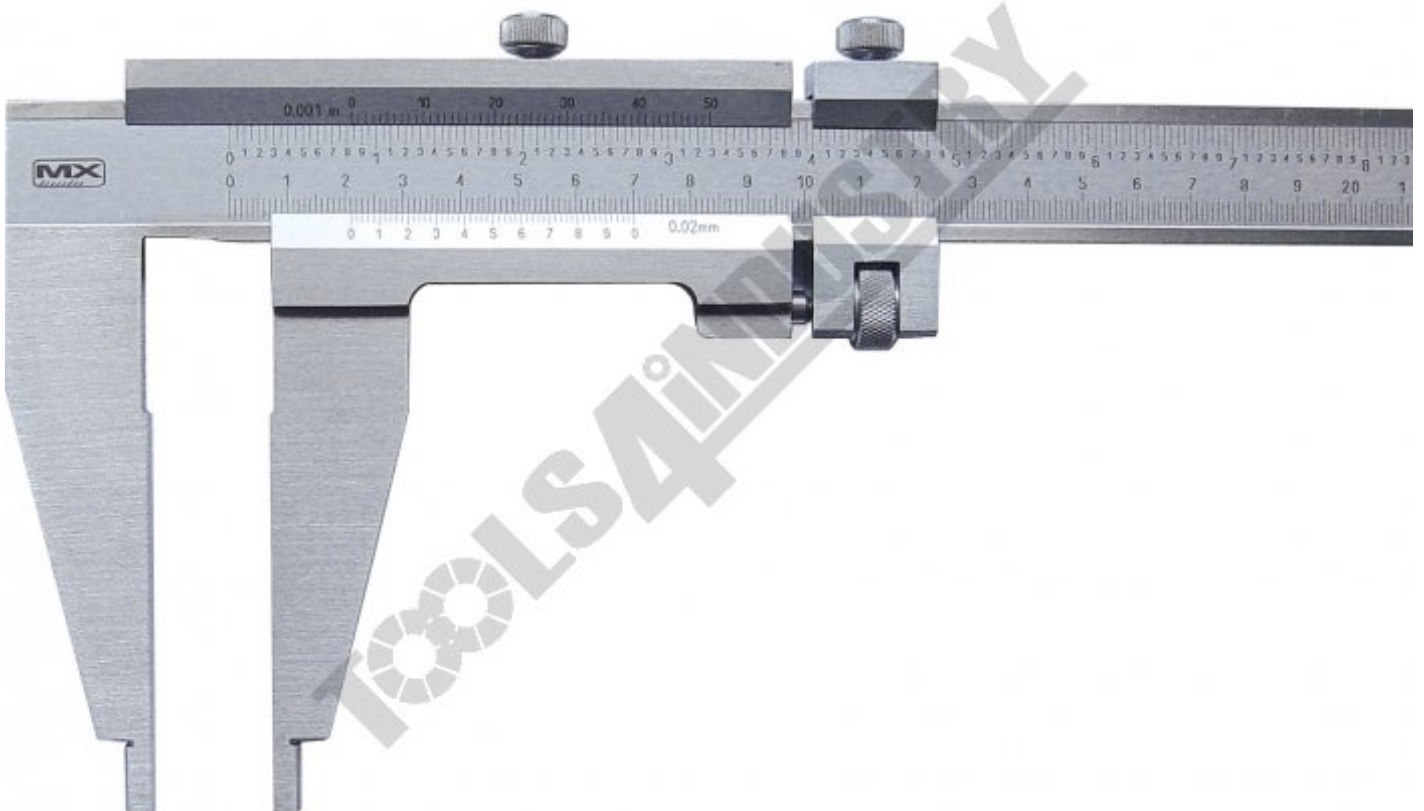

MEASUMAX Vernier Calipers 33-1996



Metric and Imperial Graduations

Features

- Precision vernier calipers with stainless steel body and slides
- Clear graduations - Metric/Imperial graduations
- Mono-block design
- Supplied in wooden case
- Instrument are manufactured to ISO 10012:2003
- An ISO9001:2000 Company

Specifications

ORDER CODE	Q1996
Range (mm / inch)	2000mm / 78"
Graduations (mm / inch)	0.02mm / 0.001"
Accuracy (mm)	±0.14
J (mm)	200
B (mm)	20
C (mm)	20
D (mm)	52