

SUNRISE



Ø25mm Round Punch - RPN1

Hi -Grade Tool Steel Imported From Japan



SUNRISE Ø25mm Round Punch - RPN1**Description**

Punch and Dies are Manufactured by Sunrise in Taiwan using Hi -Grade Tool Steel imported from Japan. The manufacturing process involves machining via hi tech CNC machines lathes & mills, vacuum heat treatment with multiple tempering at high temperatures before a final quality inspection/testing process all of which ensures an accurate, precise, durable & stable product.

Features

- PLEASE NOTE FOLLOWING RECOMMENDATIONS WHEN SELECTING DIE CLEARANCE:
- Material Thickness - 2 ~ 4mm = Die Clearance 0.2mm
- Material Thickness - 4 ~ 9.5mm = Die Clearance 0.7mm
- Material Thickness - 10 ~ 14.5mm = Die Clearance 1.2mm
- Material Thickness - 15 ~ 19.5mm = Die Clearance 1.7mm
- Material Thickness - 20 ~ 24mm = Die Clearance 2.2mm

Specifications

SUNRISE Ø25mm Round Punch - RPN1

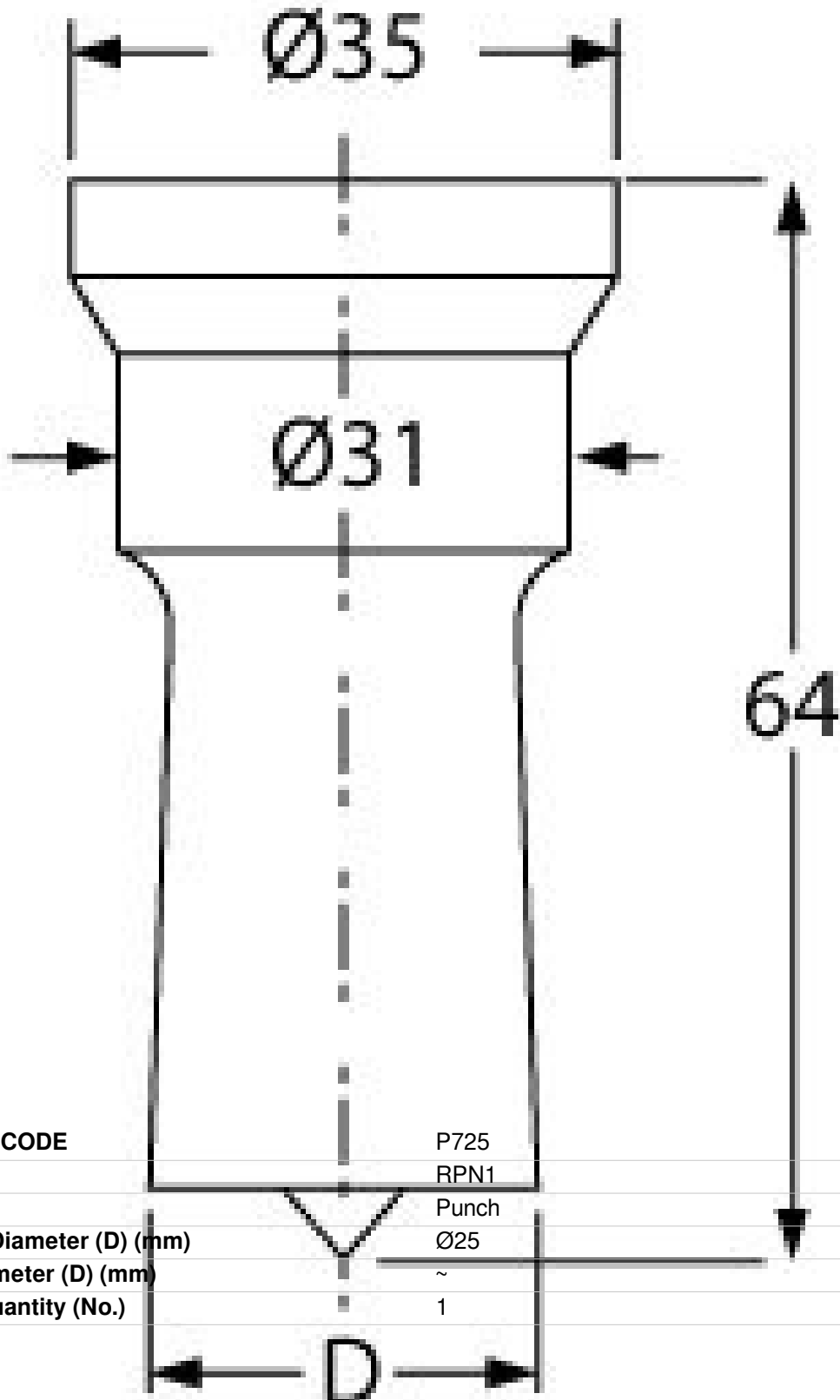

ORDER CODE	P725
MODEL	RPN1
Type	Punch
Punch Diameter (D) (mm)	$\text{Ø}25$
Die Diameter (D) (mm)	~
Pack Quantity (No.)	1