

**SUNRISE**



**Ø14mm Round Punch - RPN1**

**Hi -Grade Tool Steel Imported From Japan**



**SUNRISE Ø14mm Round Punch - RPN1****Description**

Punch and Dies are Manufactured by Sunrise in Taiwan using Hi -Grade Tool Steel imported from Japan. The manufacturing process involves machining via hi tech CNC machines lathes & mills, vacuum heat treatment with multiple tempering at high temperatures before a final quality inspection/testing process all of which ensures an accurate, precise, durable & stable product.

**Features**

- PLEASE NOTE FOLLOWING RECOMMENDATIONS WHEN SELECTING DIE CLEARANCE:
- Material Thickness - 2 ~ 4mm = Die Clearance 0.2mm
- Material Thickness - 4 ~ 9.5mm = Die Clearance 0.7mm
- Material Thickness - 10 ~ 14.5mm = Die Clearance 1.2mm
- Material Thickness - 15 ~ 19.5mm = Die Clearance 1.7mm
- Material Thickness - 20 ~ 24mm = Die Clearance 2.2mm

**Specifications**

**SUNRISE Ø14mm Round Punch - RPN1**

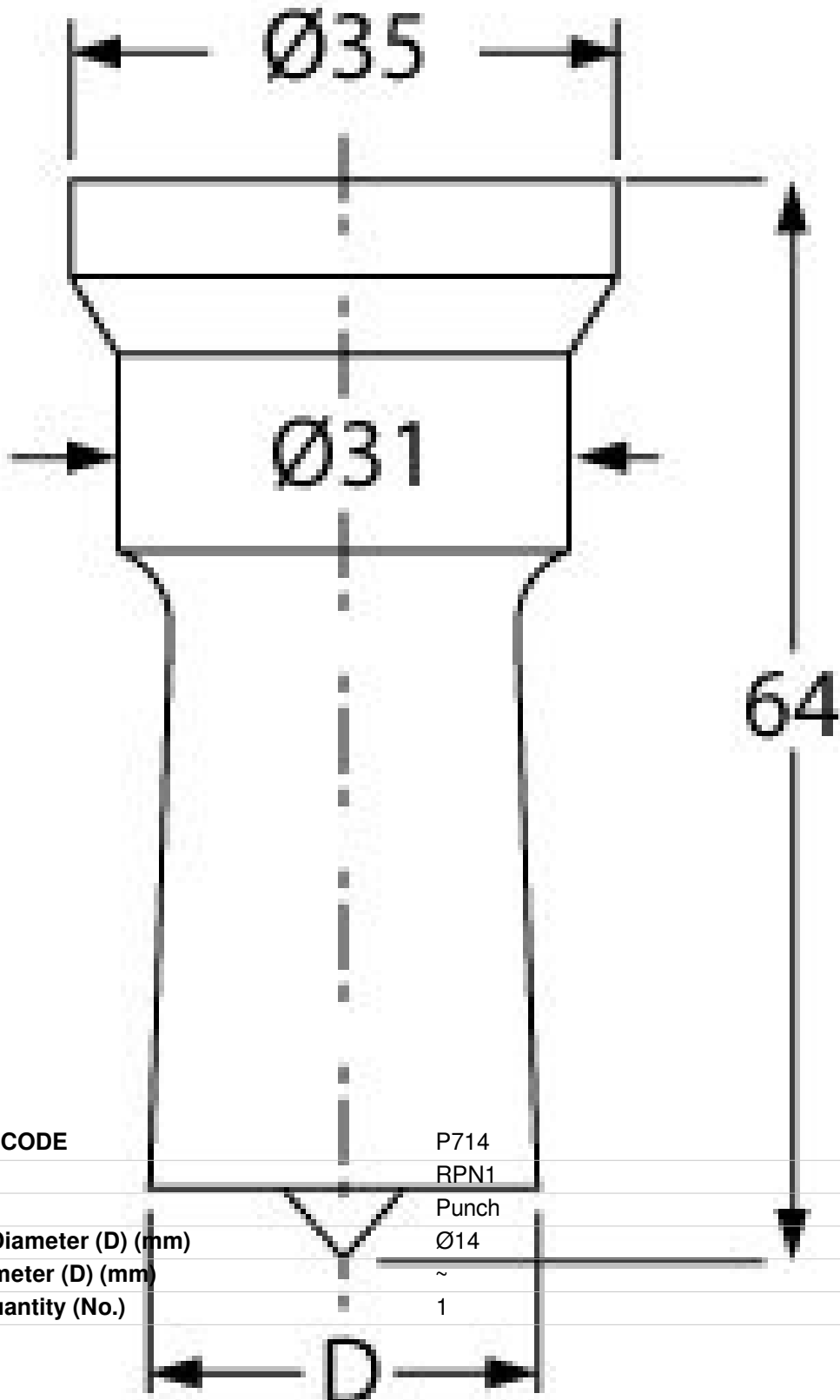

ORDER CODE	P714
MODEL	RPN1
Type	Punch
Punch Diameter (D) (mm)	$\text{Ø}14$
Die Diameter (D) (mm)	~
Pack Quantity (No.)	1