

SUNRISE



14 x 30mm Slotted Punch

Hi -Grade Tool Steel Imported From Japan



SUNRISE 14 x 30mm Slotted Punch

Top View

Description

Punch and Dies are Manufactured by Sunrise in Taiwan using Hi -Grade Tool Steel imported from Japan.

The manufacturing process involves machining via hi tech CNC machines lathes & mills, vacuum heat treatment with multiple tempering at high temperatures before a final quality inspection/testing process all of which ensures an accurate, precise, durable & stable product.

Features

- PLEASE NOTE FOLLOWING RECOMMENDATIONS WHEN SELECTING DIE CLEARANCE:
- Material Thickness - 2 ~ 4mm = Die Clearance 0.2mm
- Material Thickness - 4 ~ 9.5mm = Die Clearance 0.7mm
- Material Thickness - 10 ~ 14.5mm = Die Clearance 1.2mm
- Material Thickness - 15 ~ 19.5mm = Die Clearance 1.7mm
- Material Thickness - 20 ~ 24mm = Die Clearance 2.2mm

Specifications

SUNRISE 14 x 30mm Slotted Punch

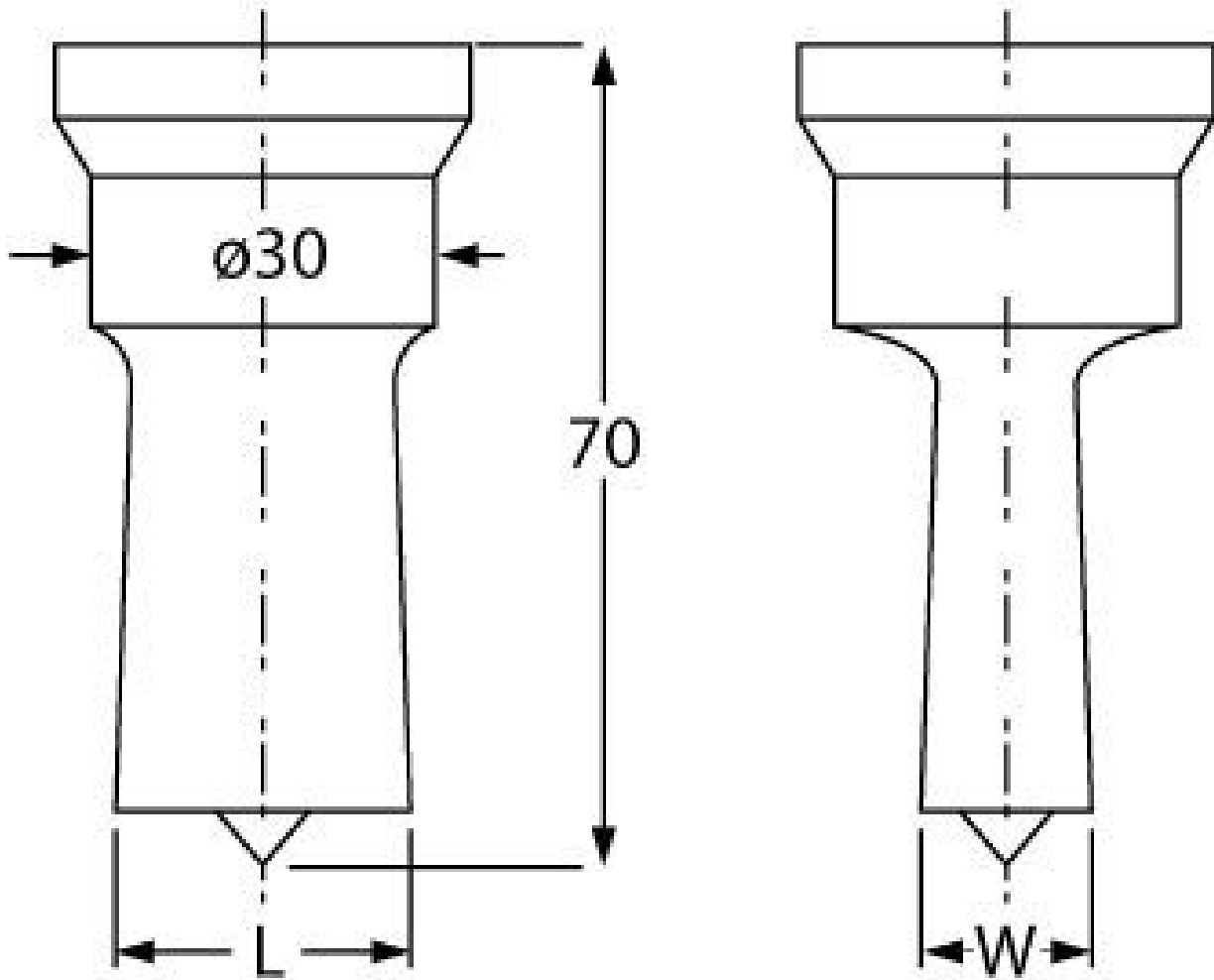

SUNRISE 14 x 30mm Slotted Punch

ORDER CODE

SUNRISE 14 x 30mm Slotted Punch

	P6101
Shape - Type	Slotted Punch - 0P1
Square or Slot Hole Size (W x L) (mm)	14 x 30
Punch Locating Diameter x Length (mm)	Ø30 x 70mm
Die Outside Body Diameter x Height (mm)	~