

**SUTTON TOOLS**



**10mm HSS End Mill - 8% Cobalt**



**SUTTON TOOLS 10mm HSS End Mill - 8% Cobalt**



4 Flute

**Description**

For precision finish milling applications

**Features**

- 4 Flute Endmill R30 N
- Suitable for materials up to 1000 N/mm<sup>2</sup>
- TiCN for longer tool life

**Specifications**

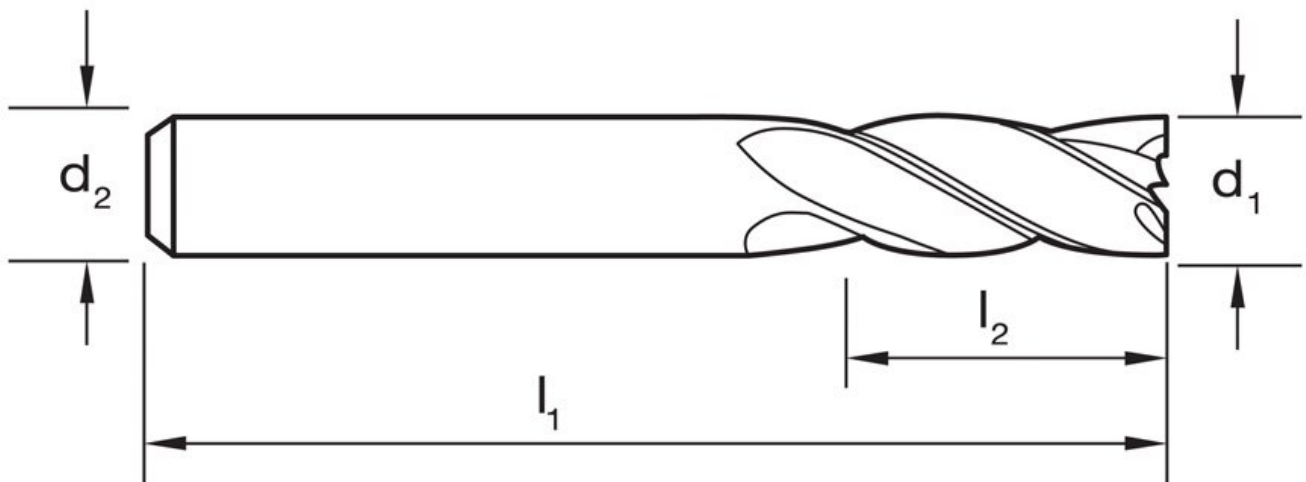

<b>ORDER CODE</b>	M3166
<b>Effective Cutting Diameter (d1)</b>	10mm
<b>Flute</b>	4
<b>Series</b>	~
<b>Type</b>	End Mill

**SUTTON TOOLS 10mm HSS End Mill - 8% Cobalt**

<b>Shank Size (d2)</b>	10mm
<b>1st Maximum Cutting Depth (l2)</b>	25mm
<b>Overall Length (l1)</b>	75mm
<b>Cobalt (CoHSS)</b>	8% Cobalt
<b>Shank Type</b>	Plain Shank