

KENNAMETAL

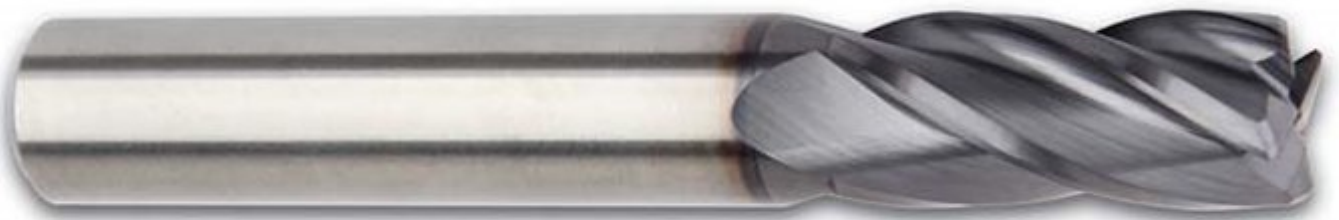

5mm Solid Carbide End Mill

GOmill™ General Purpose Plain Shank



KENNAMETAL 5mm Solid Carbide End Mill



4 Flute

Description

The GOMill GP series offers plunging, slotting, and profiling with long tool life in a wide range of workpiece materials. These end mills are designed to provide high Metal Removal Rates (MRR) and to achieve good surface quality at an excellent cost-benefit ratio. A wide range of diameters and lengths are available with chamfered edge and ball nose as stocked standard.

Uses and Applications

- Ramping: Blank
- Side Milling/Shoulder Milling: Square End
- Corner Style: Corner Chamfer
- Helix Angle: 30°
- Slotting: Square End

Features

- Solid carbide end mill with stepped parallel shank according to DIN 6527.
- Solid carbide end mill with excellent cost-benefit ratio.
- Eccentric relief increases cutting edge stability for long tool life and high surface quality.
- Eccentric relief eases regrinding and reduces reconditioning cost.
- Center cutting for plunging and ramping operations.

Specifications

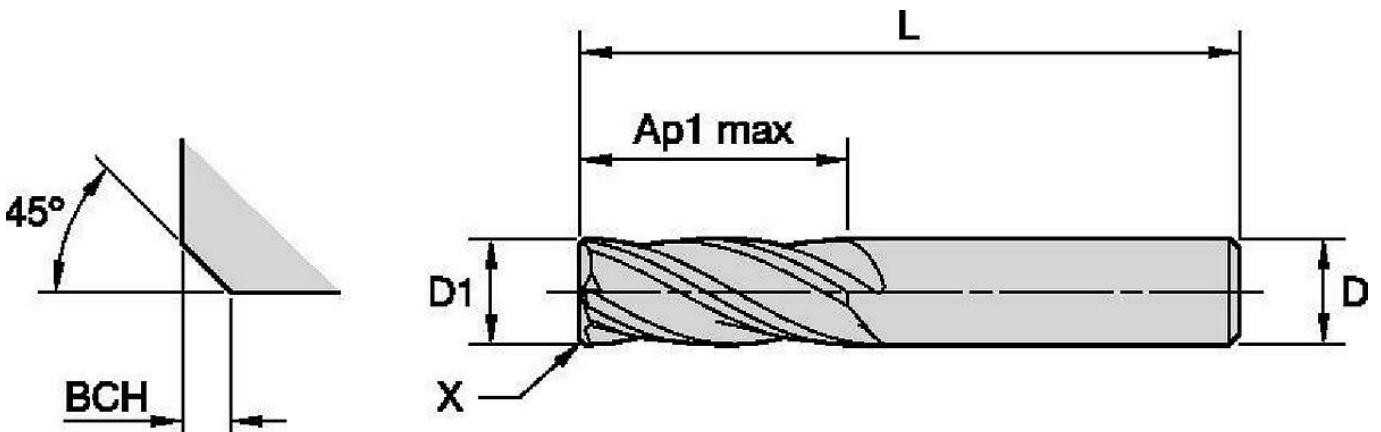

KENNAMETAL 5mm Solid Carbide End Mill

ORDER CODE

KENNAMETAL 5mm Solid Carbide End Mill

M3062

Type	End Mill
Flute	4
Unit of measurement	Metric
Effective Cutting Diameter (D1)	5.0 mm
Shank (D)	6.0 mm
1st Maximum Cutting Depth (Ap1max)	13.0 mm
Overall Length (L)	57.0 mm
Corner Chamfer Width (BCH)	0.10 mm