

GATOR PS3-315/D1-8

gator chucks

3 Jaw Self Centring Lathe Chuck

Ø315mm

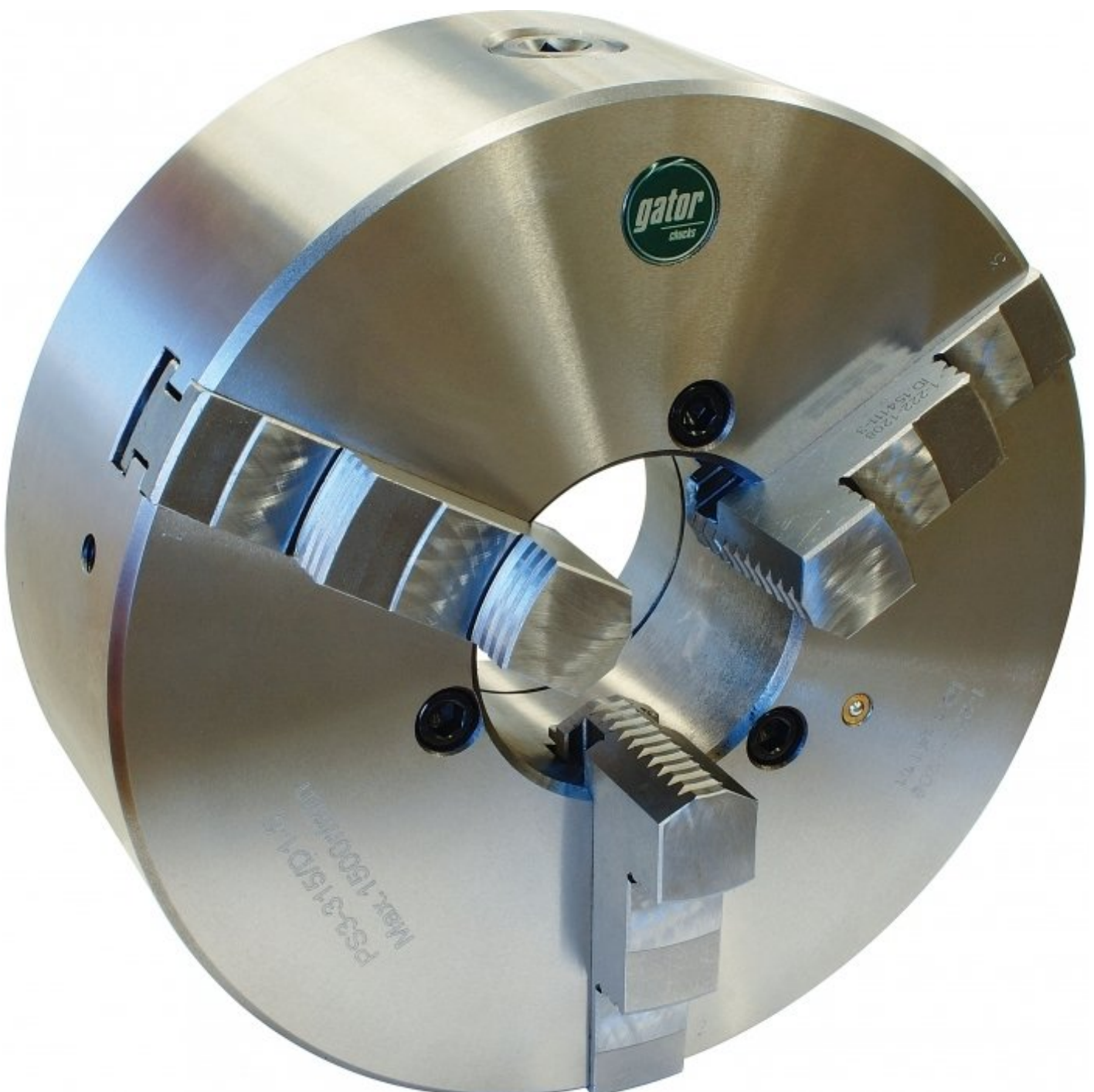

GATOR 3 Jaw Self Centring Lathe Chuck PS3-315/D1-8



Front View



Camlock Mount



Included Accessories

Description

PS Series semi steel body lathe chucks are supplied with one piece standard and reverse jaws.

Gator is a world class state of the art producer of manual lathe chucks with over 30 years of manufacturing experience and production excellence. Gator chucks are manufacturing to DIN 55029 standard and built to last for precision machining applications. The state of the art, ISO 9001-2000 manufacturing facility is quality focused producing chucks for the worldwide market.

The PS Series lathe chucks are available in direct mount or back plate mount.

Features

- Comprehensive quality assurance and accuracy testing ensure standards remain high
- Each chuck is supplied with a set of inside and outside jaws and a chuck key
- All bearing surfaces are precisely machined
- Scroll plate is drop forged from fine alloy steel and finished with case hardening
- Jaw teeth, guideways & pinions are hardened & ground

Includes

- Outside jaws
- Inside jaws
- Chuck key

Specifications

GATOR 3 Jaw Self Centring Lathe Chuck PS3-315/D1-8

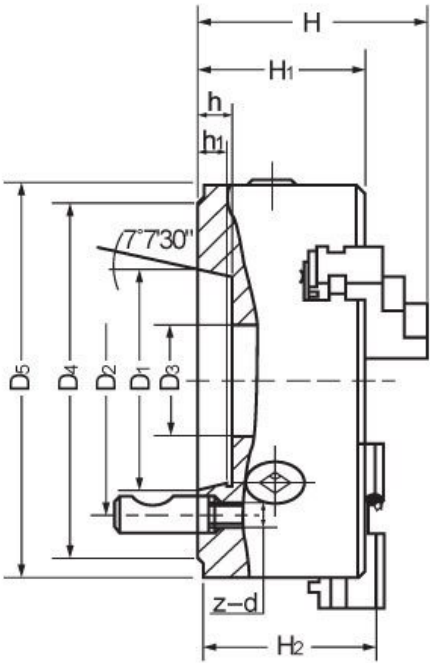

CAMLOCK

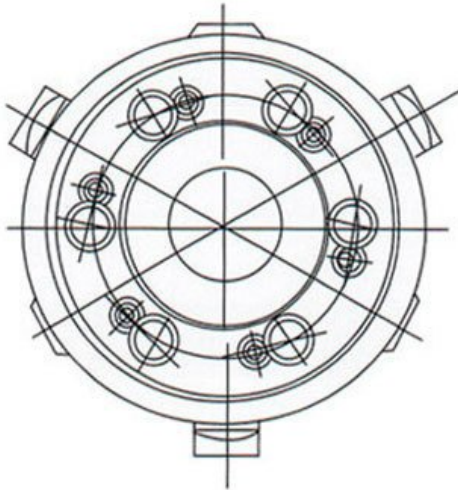

GATOR 3 Jaw Self Centring Lathe Chuck PS3-315/D1-8

ORDER CODE

GATOR 3 Jaw Self Centring Lathe Chuck PS3-315/D1-8

C7128

Chuck Size (mm)	Ø315
Camlock	D1-8
Outside Jaw (mm)	10 - 131
Inside Jaw (mm)	90 - 315
Speed (rpm)	1500
D1 (mm)	139.72
D2 (mm)	171.4
D3 (mm)	103
H (mm)	175
H1 (mm)	117.7
h (mm)	18
Nett Weight (kg)	50