

FUERDA

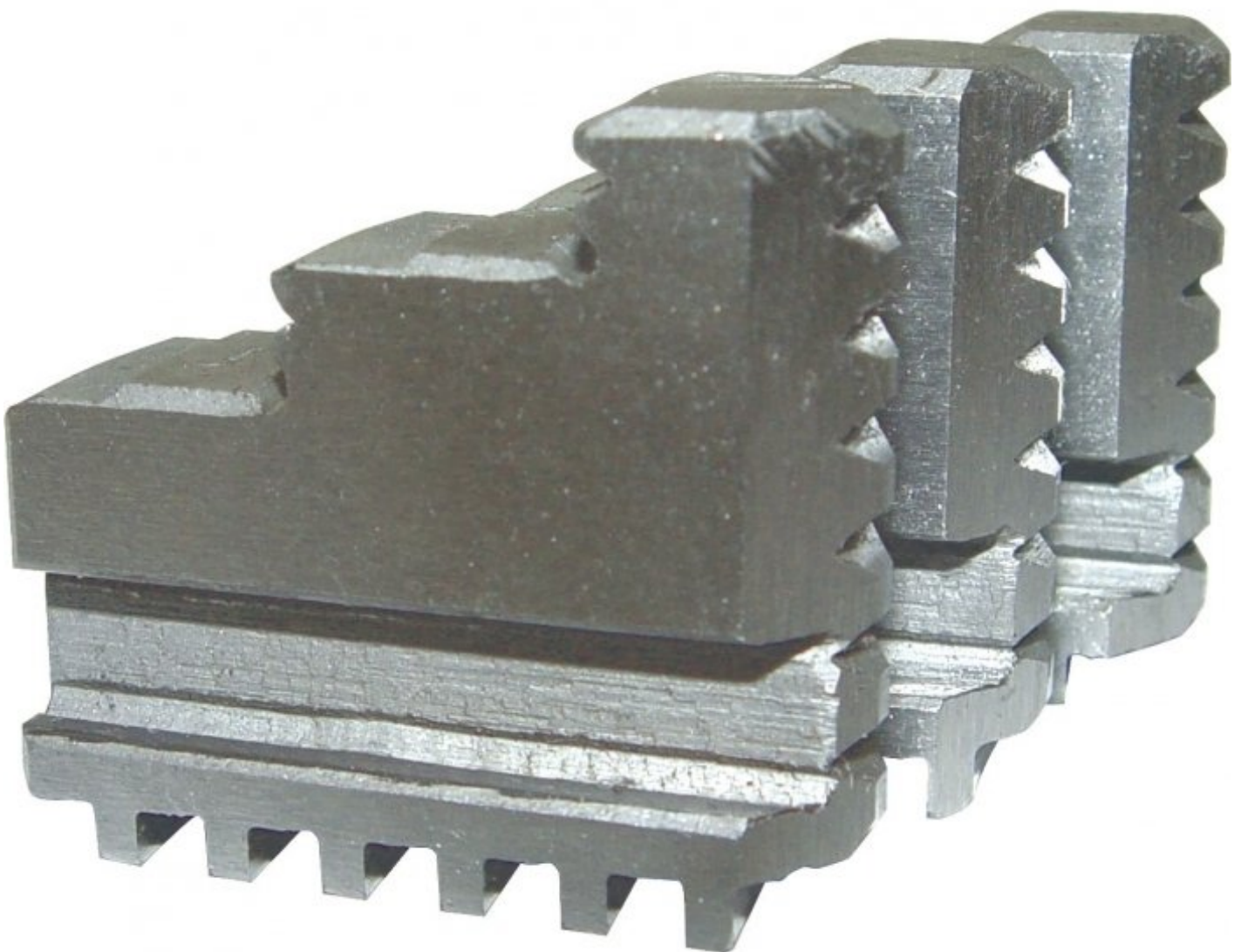

Standard Hard Jaw Set

Suits Ø100mm 3 Jaw Lathe Chuck



FUERDA Standard Hard Jaw Set

Description

1 set of hardened steel replacement jaws to suit Fuerda K11 chucks

Specifications

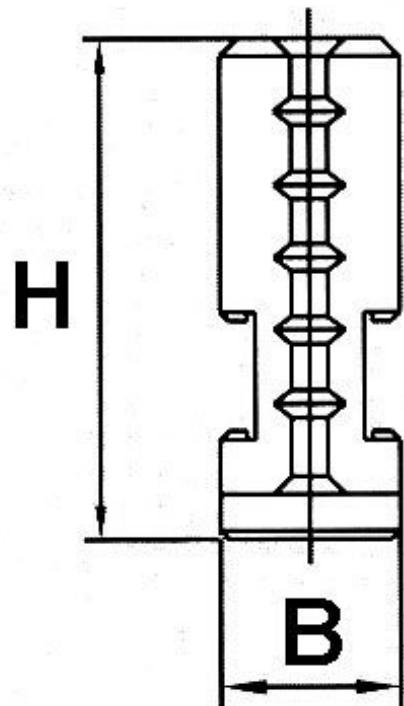
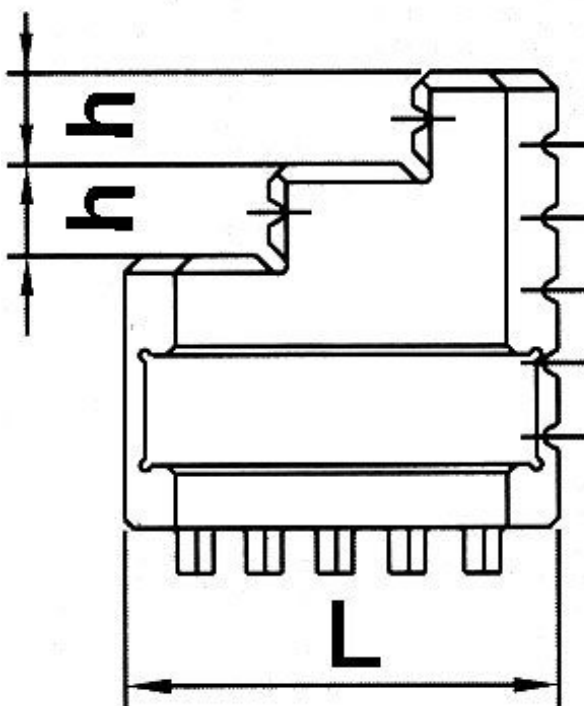
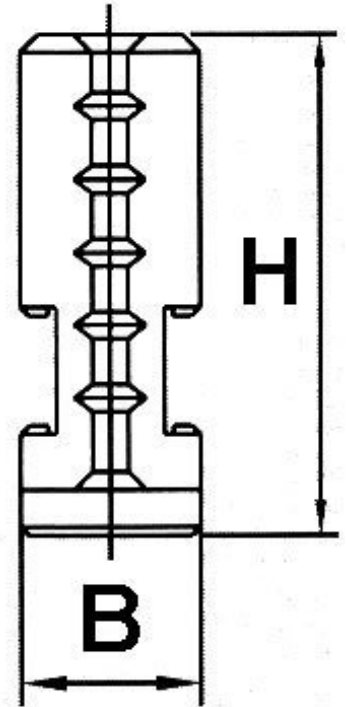
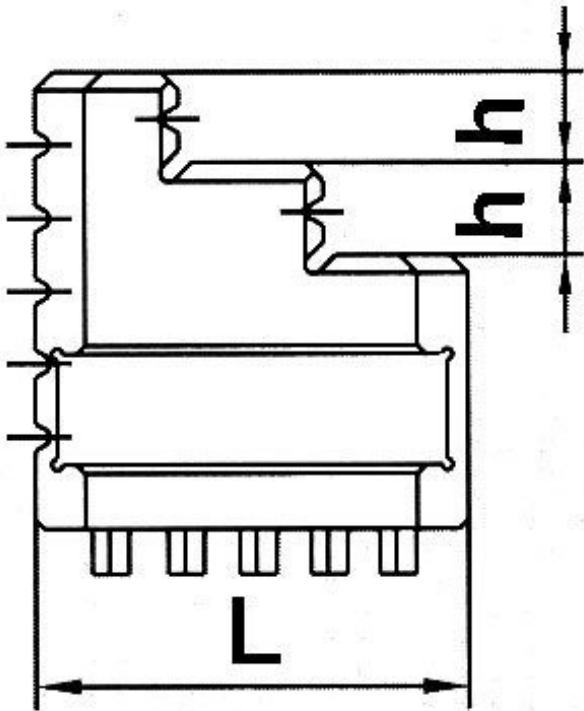

FUERDA Standard Hard Jaw Set

ORDER CODE

FUERDA Standard Hard Jaw Set

C2870

Suits 3 Jaw Chuck Size (mm)	Ø100
Jaw Type	Standard
L (mm)	42
B (mm)	15
H (mm)	38
h (mm)	7